

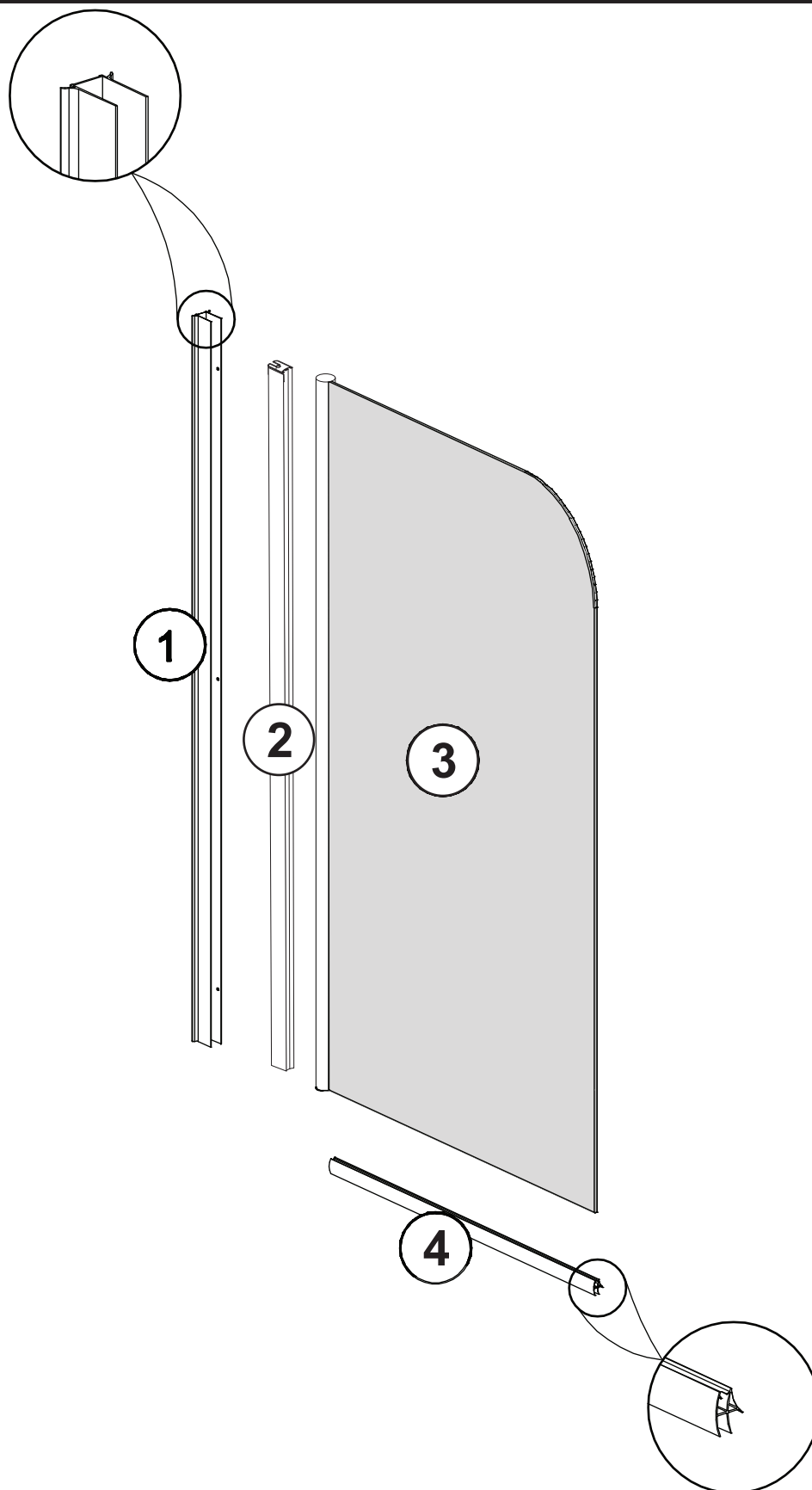

# CRISTAL 1

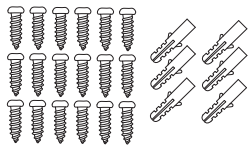
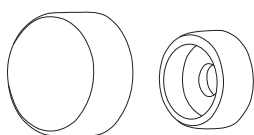
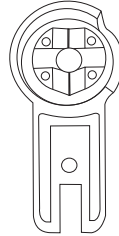
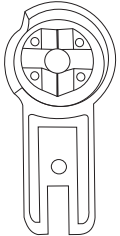
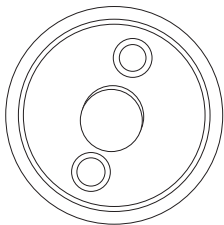

numer	symbol	nazwa części	grupa cenowa	uwagi
1	201020121	profil naścienny	I	
2	201020122	profil boczny	I	wymaga potwierdzenia dostępności/ceny
3	301020141	szyba + profil Cristal 1	P	wymaga potwierdzenia dostępności/ceny
4	104020199	dolna uszczelka	G	

### Cristal 1

1 	2 	3 	4 	5 
6 	7	8	9	10
11	12	13	14	15
16	17	18	19	20

numer	symbol	nazwa części	grupa cenowa	uwagi
1	701010052	zestaw wkrętów do montażu parawnu	E	
2	802010005	zaślepka wkrętów profilu	B	
3	702010006	zawias prawy	H	
4	702010005	zawias lewy	H	
5	702010031	oś zawiasu	E	
6	104020200	uszczelka profilu bocznego	G	wymaga potwierdzenia dostępności
7				
8				
9				
10				
11				
12				
13				
14				
15				
16				
17				
18				
19				
20				